

Variable speed wastewater pumping

During the last 10-15 years the industry has seen a significant increase in the adaptation of variable frequency drives (VFD's) in wastewater transport systems. A general desire is to better control the wastewater flow through the pump stations. Variable speed systems can provide a more flexible and powerful solution compared to using constant-speed pumps.

Introduction

Wastewater pumps have traditionally been operated in an on-off mode for small as well as large wastewater pump stations. Because the inflow of wastewater is varying over time and is often only a fraction of a pump's required capacity engineers have looked for ways to operate wastewater pumps at a reduced capacity in order to optimize performance while reducing operating costs. Before solid state variable frequency drives became commonplace speed control solutions such as two-speed motors and variable voltage windings were used to achieve variable flow pumping. During the last 10-15 years the industry has seen a significant increase in the adaptation and acceptance of variable frequency drives (VFD's) in wastewater transport systems. A general desire is to optimize the wastewater flow through the pump stations. Variable speed systems can provide a more flexible and powerful solution compared to using constant-speed pumps. Pumping with variable speed pumps can result in better process control, energy savings, smoother operation and reduced maintenance costs for the pump station, *when applied correctly*.

Some wastewater operators that have installed variable speed pump systems have noted that there were no savings in energy usage and some municipalities actually reported an increased energy usage. An increased incidence of pump clogging has also been experienced. This is directly attributed to reduced operating speed. The power absorbed by the impeller will drop by the cube of the speed change and a wastewater pumps ability to pass larger solids will diminish as speed is reduced for conventional non-clog pumps. The increase in energy usage comes from two phenomenon, *partial clogging of the impeller* and *operation away from the pump's best efficiency point*. The first is a

| CONTENTS | PAGE |
|---|------|
| Pump and pump system aspects | 2 |
| Pump sumps | 2 |
| Pump suction and discharge piping..... | 2 |
| Check valves..... | 2 |
| Water hammer..... | 2 |
| Minimum speed | 2 |
| Pump controls and variable speed drive aspects..... | 3 |
| Controlling pumps..... | 3 |
| Drive starting current and starting torque | 3 |
| Drive cooling and ventilation requirements..... | 4 |
| EMC and motor requirements..... | 4 |
| Specific energy..... | 5 |
| Process control aspects..... | 6 |
| Variable speed pump systems | 6 |
| Minimizing energy usage..... | 7 |
| Pump sump level control | 8 |
| On-Off control | 8 |
| Constant level control..... | 8 |
| Variable level control..... | 9 |
| Minimum flow control..... | 9 |
| Pump mechanical aspects | 10 |
| Reverse rotation | 10 |
| Pump hydraulic aspects | 10 |
| The hydraulic end | 10 |
| Conclusion..... | 12 |

result of extended run times as VFD driven pumps will have long operational cycles at lower speeds, the other is a result of pumping in systems where the static head accounts for a high degree of the overall system head.

It is important to consider all pump system and pump station aspects in order to achieve a well operating pump station. These aspects include system curves, pump and motor selection, process control, electrical aspects, potential for energy saving, control strategies, pipe system components and more. In doing so, it is possible to maximize the energy savings from variable speed wastewater pumping while ensuring clog free operation. This paper discusses many of these aspects.

Pump and pump system aspects

Pump Sumps

It is important to keep the pump sump clean in order to prevent an accumulation of organic and inorganic material resulting in odor and maintenance problems. Variable speed controls can be programmed to perform sump cleaning cycles on a regular basis in order to reduce the risk of sediment buildup and accumulation of floating debris.

During a sump cleaning cycle, the sump level is pumped down to a level at which the pump starts to draw air ("snore"). As the liquid level is drawn down surface vortices will form and grow in strength and frequency. The moment before the pump starts to snore strong forces add high local velocities from surface vortices will draw floating debris into the pump. It is essential to limit pump operation at snore to a minimum in order to minimize the amount of air in the discharge line and to prevent potential exposure to high pump vibration levels.



Figure 1: A wastewater sump covered with floating debris.

Pump Suction and Discharge Piping

The fluid velocity in the force main affects the degree of force main sedimentation as well as the energy consumption due to friction loss. Operating with high velocities in the force main reduces the risk for sediment buildup although it increases the energy consumption. In contrast, operating with low fluid velocities in the force main reduces energy consumption and increases the risk of sedimentation. It is therefore important to consider optimize fluid velocity with energy consumption when selecting suction, discharge and force main pipe sizes.

With variable speed pumping it is possible to reduce fluid velocity below the normally recommended 0.7m/s (2.5 fps) for extended periods because of the possibility to periodically flush the discharge line by temporarily

increasing the fluid velocity by increasing the pump speed. Depending on the type and concentration of heavy sediments and grease in the media, the degree of sedimentation will differ; the higher the concentration of solids, the greater the risk of sedimentation. A variable speed controlled pump station increases the flexibility to flush the force main by increasing the pump speed. The frequency of flushing depends upon the system design, the degree of contaminants and the minimum velocity required to maintain optimal operating conditions.

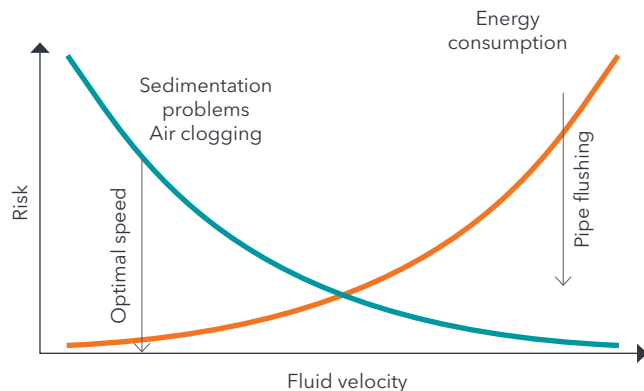

Figure 2: When flushing the discharge line on regular basis, it is possible to reduce the minimum fluid velocity below 0.7m/s without having sedimentation problems.

Check valves

In applications with variable speed pumps the liquid velocity will often be lower than normal in the pipe system. Swing check valves have lower friction losses at low velocities than ball check valves. Therefore the energy savings at reduced speed will increase when a swing check valve is chosen instead of a ball check valve.

Water hammer

Variable speed pumps have the possibility to soft-start and soft-stop by gradually increasing and decreasing the pump speed thereby reducing the impact of water hammer and wear and tear on the check valves. When the pump stop sequence is long (slow pump speed deceleration) the liquid will decelerate slowly in the force main.

Note that a VFD will not function during a power failure without immediate battery backup power available, thereby limiting its effectiveness as a water hammer protection device.

Minimum speed

Certain pump designs may have limitations on the lowest allowable pump speed. The minimum speed may be dependent on proper operation of a cooling system, shaft resonance frequencies and other issues. Consult the pump manufacturer to make sure any limitations are identified.

Pump controls and variable speed drive aspects

Controlling pumps

Functions to start and stop pumps can be achieved with simple relay systems or solid state controllers. Dedicated pump controllers and pump supervision units are commonly used today. Variable speed drives are frequently used as a means to control the speed of induction motors. For larger and more complex systems general purpose Programmable Logic Controllers (PLC's) can be used. Comprehensive custom software will then have to be written for the specific application. A variable speed drive must be controlled by software to be able to control a pump, the pump station must have a master controller to properly sequence and control all pumps.

The most modern pump controller solutions for wastewater pumps are hosted inside variable speed drives. Application specific software can be pre-installed and pre-configured in a drive dedicated for a specific application for a certain pump and motor. A system start-up can be as simple as connecting the level sensors and power cables to the drive and then pushing the start button for the system to be up and running.



Figure 3: Preprogrammed and pre-configured intelligent control for a dedicated application is quick and easy to install and start up.

Drive starting current and starting torque

The rated current of a drive must be greater than the rated motor current for the selected pump. To handle under voltage and overload situations, a current margin of 20% is generally recommended. In wastewater pumping applications, it is important that the motor can supply the impeller with full torque to handle potential clogging situations. It is therefore necessary for a wastewater pump to be equipped with a variable speed drive capable of delivering nominal torque at startup and sustaining twice the nominal torque at full operating speed for at least one second.

There are two main types of drives: scalar control and vector control drives. The scalar control drive generates a predefined voltage as a function of the frequency. A vector control drive is based on a model of the motor and analyzes the voltage and current required to control the pump. Using the feedback data from the motor, the starting current can be decreased while the starting torque can be increased.

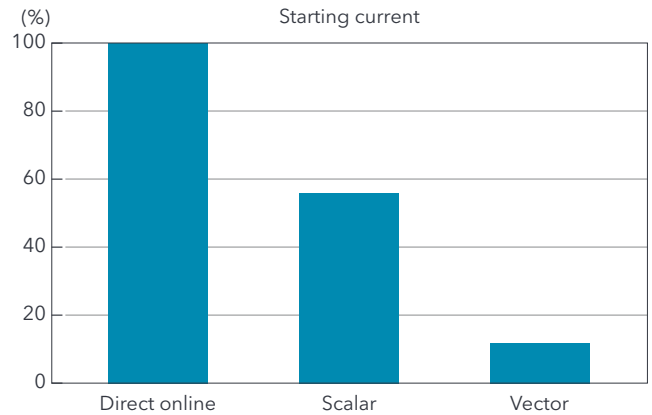

Figure 4: When starting a pump using a VFD with vector control, the starting current is considerably lower than when starting the pump direct online.

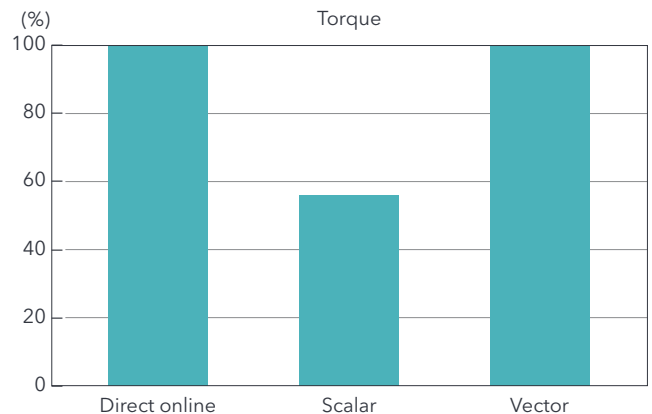

Figure 5: When starting a pump at zero speed, the torque of pump motor controlled by a VFD with vector control is the same as a pump motor with a direct online starter.

Drive cooling and ventilation requirements

Variable frequency drives typically have a 96-97% efficiency, which means that 3-4% of the transmitted power is lost as heat. To prevent drive overheating, these losses must be transferred to the ambient air. To enable cooling air to flow around the drive, free space above and below the drive is required. For ambient temperatures above 40°C (104°F), derating of the drive is typically required. Air conditioners or ventilation fans may be required at higher ambient temperatures. For drive installations at high altitudes (exceeding 1000 m (3300 ft.) above sea level) derating of the drive is generally required in order to compensate for poor cooling at high altitudes.

EMC and motor requirements

In order to ensure a power supply free from excessive harmonics and prevent electrical equipment problems, it is important to follow good EMC (Electromagnetic compatibility) engineering practices when designing a drive system. Best practices when designing a VFD system includes:

- Use screened power cables and position the cable screen as close as possible to the connection terminals
- Use screened signal cables
- Use twisted signal leads along the entire cable route
- Ground the cable screens at both ends
- Use the shortest possible power cables
- Separate signal and power cables by more than 500 mm (1.5ft) in parallel runs

The use of Class H motor insulation and trickle impregnation provides solid protection against corona effects for nominal motor voltages up to 600 V and pump cable lengths up to 50 m (150 ft). Longer supply cables can cause full wave reflection, which can double voltage stresses on the windings. When cable lengths exceed 50 m (150 ft), the use of a sine wave filter is recommended.

Electric harmonics create parasitic torques in the motor which increase the load and stress on the motor. Harmonics can be reduced by the use of a common mode filter.

A switching frequency of approximately 7-8 MHz is recommended to obtain a good compromise between the electrical noise levels and the losses in the motor and the drive. The switching frequency determines the rate at which

the drive "chops" the voltage in order to transform the voltage to the desired frequency.

Some induction motors require a 5-10% power margin when operated on a variable speed drive, other motors have been designed to operate on drives up to the rated shaft power. When operating a drive, consult the motor manufacturer for power margin requirements.

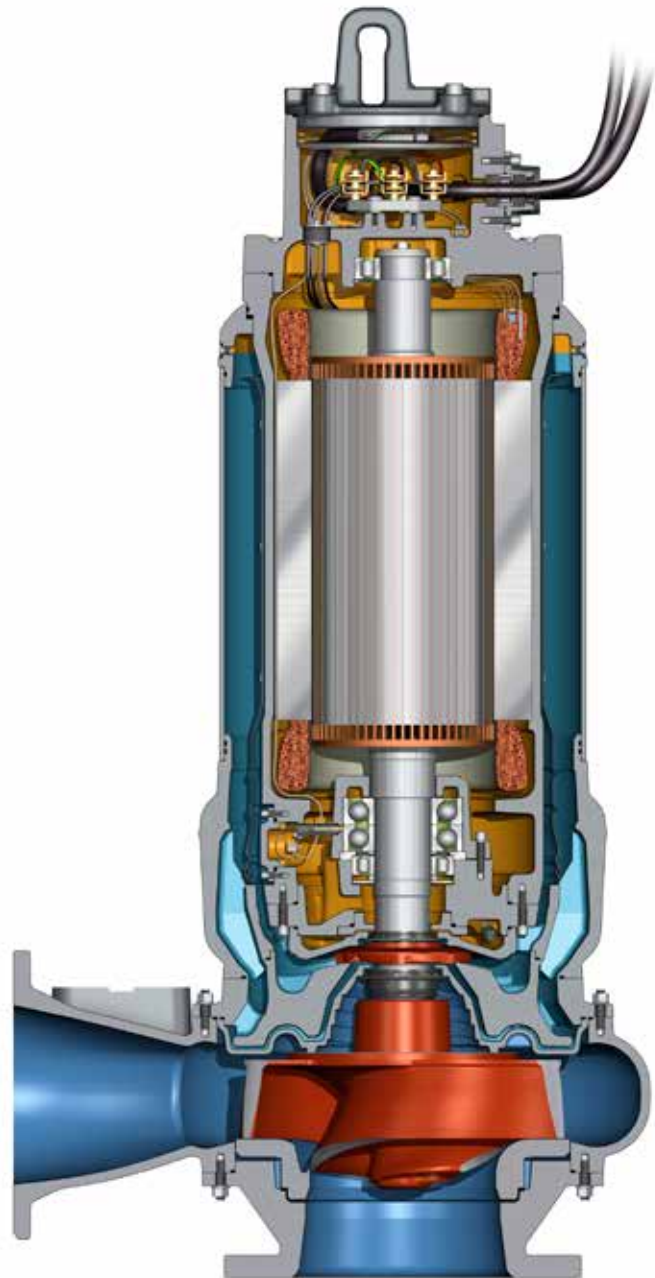

Figure 6: A class H motor insulation system and VPI motor impregnation provides good protection against corona effects.

Specific energy

Introduction

The most useful measure to compare energy efficiency in pump systems is specific energy. Specific energy is defined as the amount of energy it takes to move a certain liquid volume in pump system. A lower number means lower energy consumption. The specific energy value takes into account all parts of a pump system, i.e. electrical, mechanical and hydraulic efficiencies including losses in the pipe system. Note that the specific energy value is valid for the particular pump system that it was calculated for; *it cannot be compared to another pump system without making adjustments for system differences.*

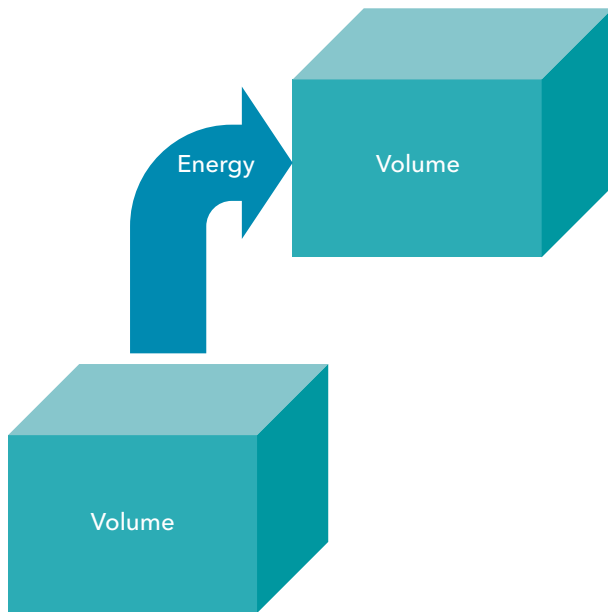

Figure 7: Specific energy is a measure of how much energy it takes to move one cubic meter of liquid from one point to another.

Specific energy is calculated with the following formula:

$$E_s = \frac{\text{energy} \left[\frac{kWh}{m^3} \right]}{\text{volume} \left[\frac{kWh}{Mgal} \right]}$$

where

- E_s = Specific energy [kWh/m³]; [kWh/Mgal]
- $energy$ = Energy required to transport a given liquid volume (kWh)
- $volume$ = Volume of pumped liquid (m³, Mgal)

Specific energy can also be calculated by using this alternate formula:

$$E_s = \frac{h}{\eta} \rho g * \frac{1}{3600000} \left[\frac{kWh}{m^3} \right]$$

$$E_s = \frac{h}{\eta} \rho g * \frac{1}{639} \left[\frac{kWh}{Mgal} \right]$$

where

- E_s = Specific energy [kWh/m³]; [kWh/Mgal]
- h = Total head delivered from the pump [m]; [ft]
- η = Total efficiency of the pump [%]
- ρ = Density of the fluid [kg/m³]; [lb/cu-ft]
- g = Gravitational constant [m/s²]; [ft/s²]

Total efficiency of the pump and motor.

Process control aspects

Variable speed pump systems

Inflow to a wastewater pump station varies considerably over a 24-hour period. The inflow is typically low during the night and peaks once in the morning and once again in the evening. Flow duration diagrams are often used to visualize the flow variations (Figure 8).

To minimize energy consumption, we should focus on two areas:

a) Reducing the total pumping head

Total head is defined as the sum of static head and losses. Since friction and point losses are directly proportional to the flow squared, it is desirable to reduce losses by decreasing the flow. As a wastewater pump normally is sized to handle maximum inflow to the pump station (duplex stations), it is possible to reduce the pumped flow during normal operation and thereby reduce the total head.

b) Maximizing pump efficiency

To achieve maximum pump efficiency, it is important to select pumps that deliver sustained efficiency (self-cleaning pumps) and that operate as close to the best efficiency point as possible. A pump that is operated at reduced speeds

should be selected well to the right of the best efficiency point (BEP) at full speed in order to achieve maximum efficiency when the speed is reduced.

Determining the optimal performance of a typical variable speed pump system requires the analysis of pump curve (Figure 9). The blue plots show three different pump system curves S1, S2 and S3.

Pump system S1: This system curve represents a lift system because the static head is larger than the friction losses. The energy saving potential of variable speed operation in lift systems is small because the pump efficiency decreases faster than the total head decreases when the pump speed is reduced.

Pump system S2: This system has a better energy saving potential than S1 because the total head decreases faster than the efficiency does when the pump speed is reduced.

Pump system S3: This is primarily a circulation system (little or no static head). Here the potential for energy saving is the greatest because the pump system efficiency is constant while the total head decreases as the pump speed is reduced.

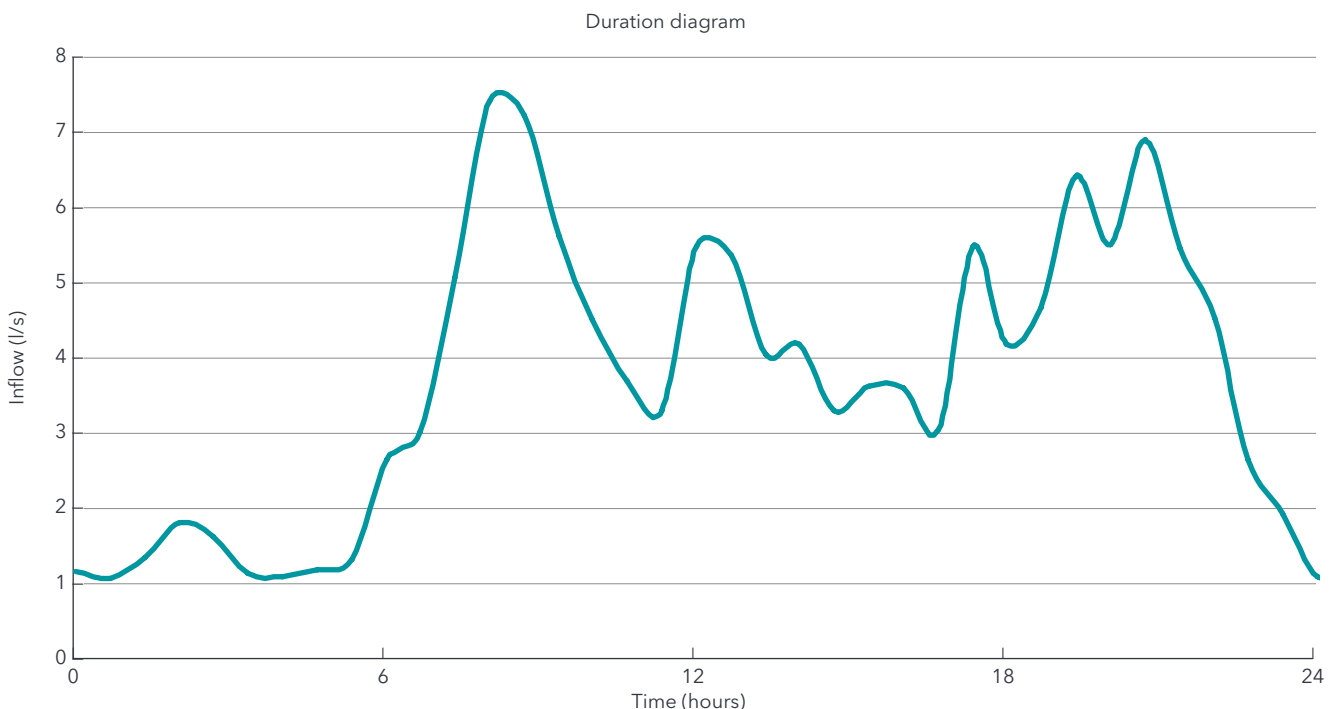

Figure 8: A wastewater flow duration diagram shows inflow as a function of time.

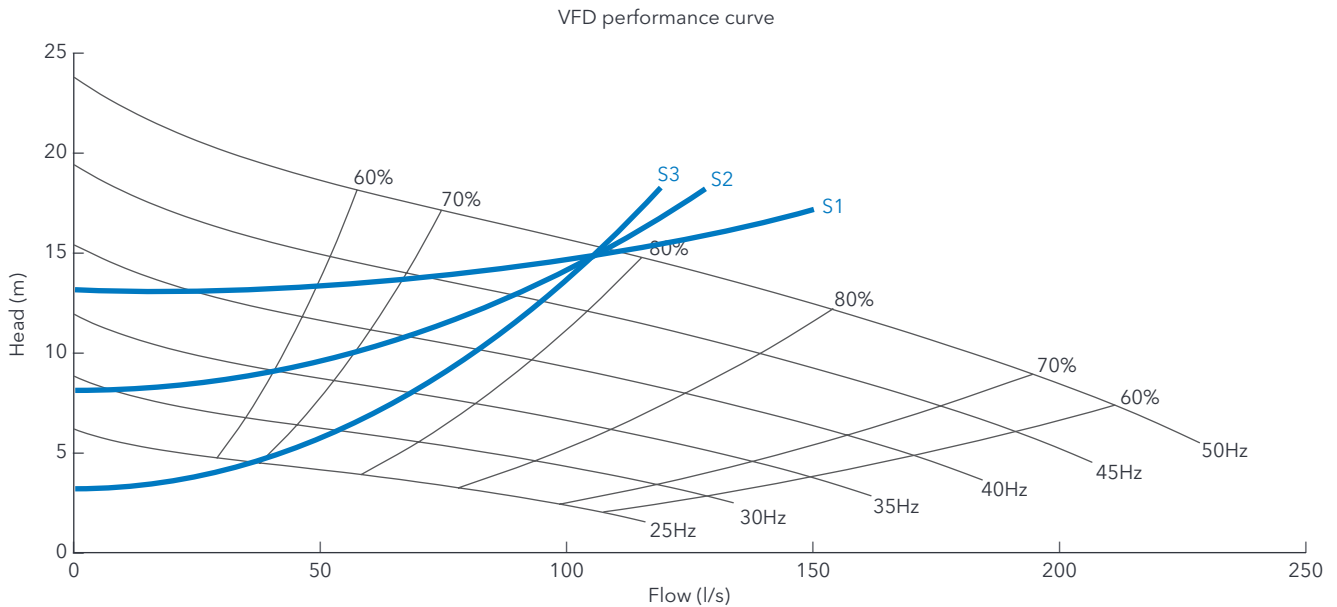

Figure 9: Possible energy savings depends upon the system curve and the pump curve.

Minimizing energy usage

Specific energy for a given system varies with the pump speed. The optimal speed from an energy savings perspective is when the pump runs at the frequency that corresponds to the minimum specific energy (see figure 10). The optimal frequency is dependent on several factors. These include the pump performance curve and the system curve, which together generate different specific energy curves. The optimal speed for system curve S3, as an example, is approximately 23 Hz when using the second formula and figure 10.

Finding the optimal frequency when operating a pump at variable speed presents challenges. One method to identify optimal speed is through the use of algorithms. Intelligent pump controls like the Flygt SmartRun™ have algorithms that provide automatic optimization of speed for minimum energy usage. Flygt SmartRun™ uses an iterative process to determine the optimal speed and adapts for system changes such as reduced pump performance or increased sedimentation in the force main.

Conducting a theoretical study of the pump system is another method to identify optimal frequency. However, there are drawbacks to this approach, including the possibilities that changes to the system occur over any given period of time. These pump system calculations

are imprecise at best or impossible due to lack of documentation of the pipe system.

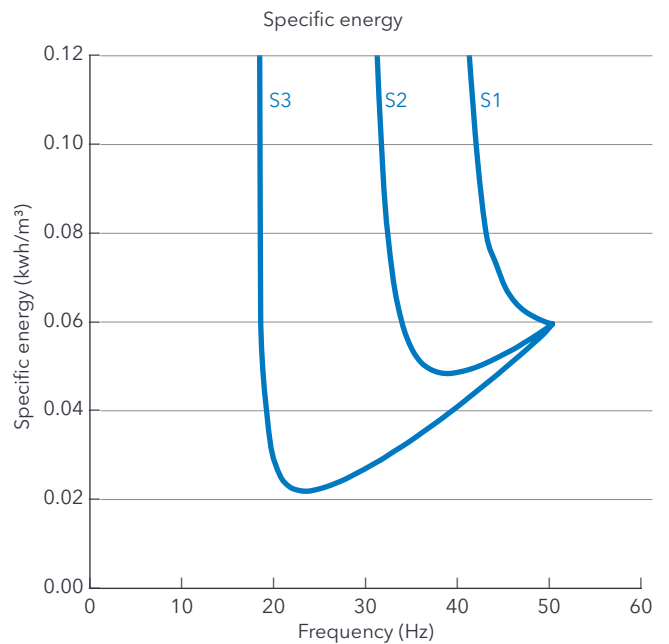

Figure 10: Different system curves will yield different specific energy curves. The minimum energy pump speed is located where the curves are at their minimum.

Pump sump level control

On-Off control

Pump stations with constant speed pumps operate in an on-off mode where distinctive start and stop levels enable the wet well to draw and fill as the pumps are started and stopped. Here the pumps are operated at their intended speed and the pumps non-clog performance will be as good as the design allows for.

Variable speed control

Two-speed pumps and variable speed operated pumps allow the station to operate at flows closer to actual inflows as opposed to design flows. Correctly implemented variable speed operation can lead to lower energy consumption. The next sections will discuss the benefits and drawbacks with different variable speed control strategies.

Traditional constant level control

The traditional control method for variable speed operation in a wastewater application is a constant level scheme (Figure 11). The controller uses the liquid level as a reference value. At low inflows, the pump will operate at too low a speed and consequently at a very low efficiency, thereby wasting energy. In addition to this the risk of sedimentation

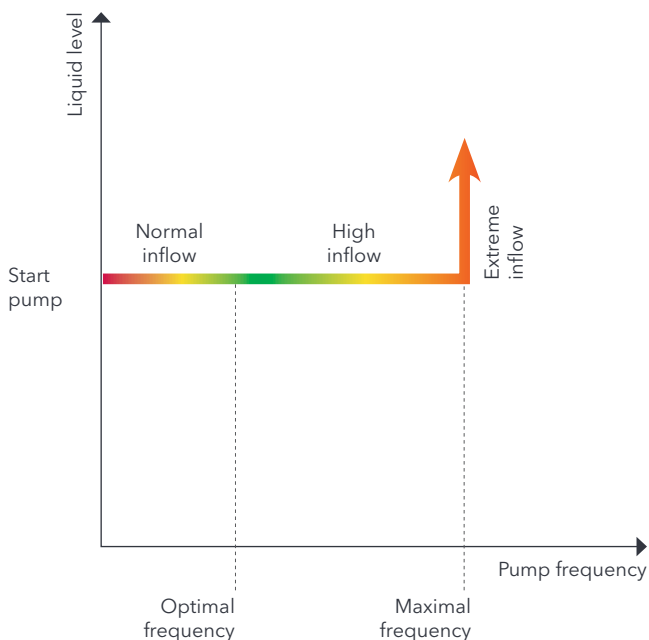

Figure 11: Traditional constant level control.

- Normal inflow: Operating at too low frequency.
- High inflow: The frequency will be controlled to keep the pumped flow equal to the inflow.
- Extreme inflow: Operation at maximum speed cannot handle the inflow. (Green color symbolizes operation at low specific energy and red color symbolizes operation with high specific energy.)

in the pipes and pump sump increases. The pump is often operating outside of its preferred operating range with a reduced life expectancy as a result. This will happen when the pump is run at a speed lower than the energy optimal speed, i.e. the speed at which the pump's specific energy consumption is at a minimum. Partial pump clogging is also more likely to occur for non-self-cleaning pumps, such as traditional closed impeller and vortex pumps.

Optimal constant level control

Using a combination of reduced speed and intermittent draw-fill operation is the most energy efficient method of controlling variable speed pumps and it is recommended for wastewater pump stations. It will eliminate the time the pump runs at a speed below the optimal speed. To achieve intermittent operation and ensure the pumps do not start and stop too frequently, it is important to establish a suitable distance between the start and stop levels, which enables the pumps to operate at the minimum energy speed for a sufficient period of time. When modern constant level control is used as a control strategy, it is necessary to set the minimum energy frequency as the optimal frequency in order to maximize energy savings and operational reliability. The control scheme can be seen in figure 12.

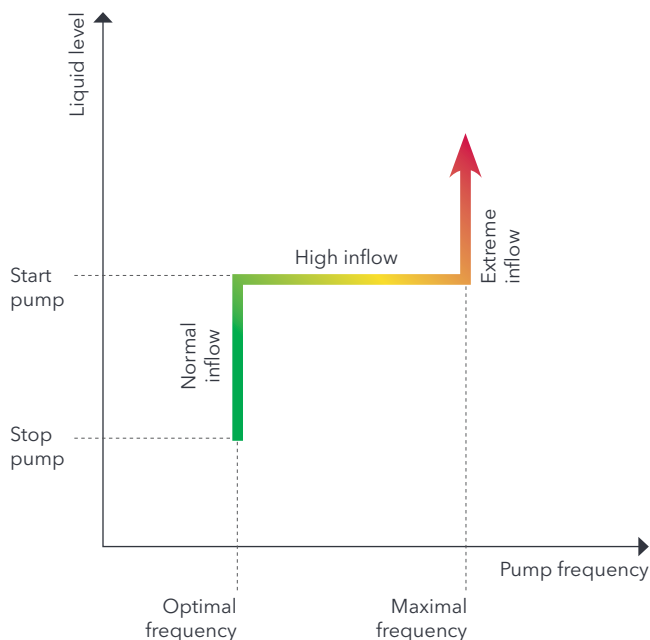

Figure 12: Optimal constant level control.

- Normal inflow: Intermittent draw-fill operation at optimal speed.
- High inflow: The frequency will be controlled to keep the pumped flow equal to the inflow.
- Extreme inflow: Operation at maximum speed cannot handle the inflow.

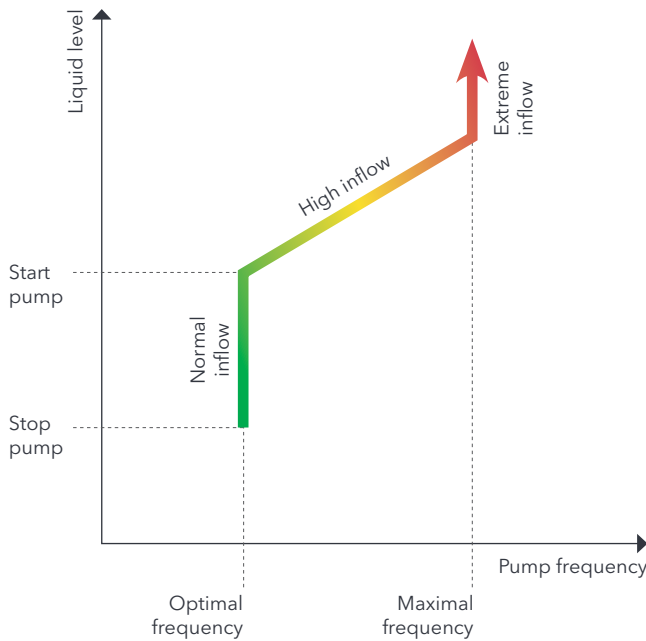

Figure 13: Variable level control.

- Normal inflow: Operating on/off at optimal frequency.
- High inflow: The frequency will increase linear to the water level until the pumped flow is equal to the inflow.
- Extreme inflow: Operating at maximum speed cannot handle the inflow.

Variable level control

Another commonly used method to control wastewater pumps is a variable level control (Figure 13). The advantage here is that the inflow can be buffered in the sump, resulting in a smoother pumped flow. With this method of control, pump speed is a function of the liquid level in the sump. Compared to constant level control, variable level control is a softer control strategy, which helps smooth out shorter inflow peaks.

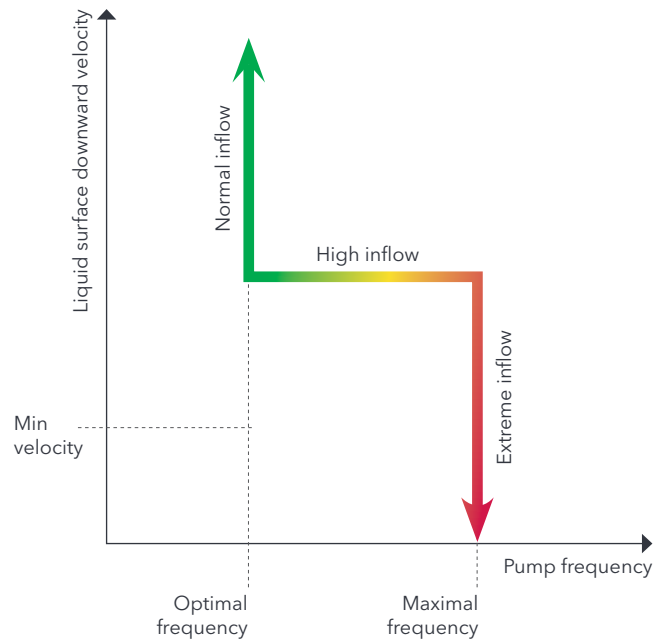

Figure 14: Minimum flow control.

- Normal inflow: Operating on/off at optimal frequency.
- High inflow: The frequency will increase to secure that the liquid surface velocity is equal to the minimum velocity.
- Extreme inflow: Operation at maximum speed cannot maintain a liquid surface velocity equal to the minimum velocity.

Minimum flow control

A fourth control method is based on the use of the time-derivative of the sump liquid level [liquid surface velocity]. This entails setting a minimum flow, which ensures that the velocity of the liquid level decrease is set at a given minimum rate. If the liquid level does not decrease with this given rate, the pump speed will automatically increase. In order to be energy efficient, the speed, must not fall below the optimal speed even if the liquid level decreases at a slower rate. The minimum flow control can be seen in figure 14.

Pump mechanical aspects

Reverse rotation

Lower speeds and slower pump acceleration/deceleration are beneficial with respect to reducing the mechanical and thermal loads on the pump and on the connected systems as forces on bearings, joints and seals will be lower.

Pump reversing is sometimes used as a means to unclog pumps. Drive reversing can be done without mechanically overloading the impeller joint and risking mechanical damage. Different pump manufacturers have different limitations on reversing.

Pump hydraulic aspects

The hydraulic end

Pump clogging is a common wastewater pumping problem. The key design criteria for a non-clog pump is its ability to pass solids without clogging the pump. Clogging can be a full or a partial clog of the impeller or the volute. A full clog exists when the pump has ceased pumping; this condition is easy to detect and highly undesirable. A partially clogged pump however, is harder to detect and most often goes unnoticed because the pump still delivers flow, although it is reduced. This can go on for long periods of time, wasting

substantial amounts of energy. If the pump is operated continuously, the pump efficiency will tend to gradually decline to levels less than half of the clean water efficiency or lower.

The clog may be caused by foreign objects but more often it's caused by normal wastewater contents, sometimes in larger sizes or heavy accumulations. There are several different types of clogging phenomena, which can affect the pump performance (head, flow and input power) in different ways depending upon the pump design.

Conventional channel impeller wastewater pumps, both single- and multi-vane as well as vortex impellers are prone to clogging due to soft and fibrous objects accumulating on the leading edges of the impeller or at the center of the impeller. This results in reduced pump efficiency and substantially increased energy consumption.

When the pump operating cycle ends, back flushing often cleans the impeller and pump, thereby pump efficiency is partially restored. If a pump operates at reduced speed it is likely to see heavier accumulation of debris because the pump operating cycle is longer and no back flushing of the impeller occurs. This is the main reason to avoid long pump cycles

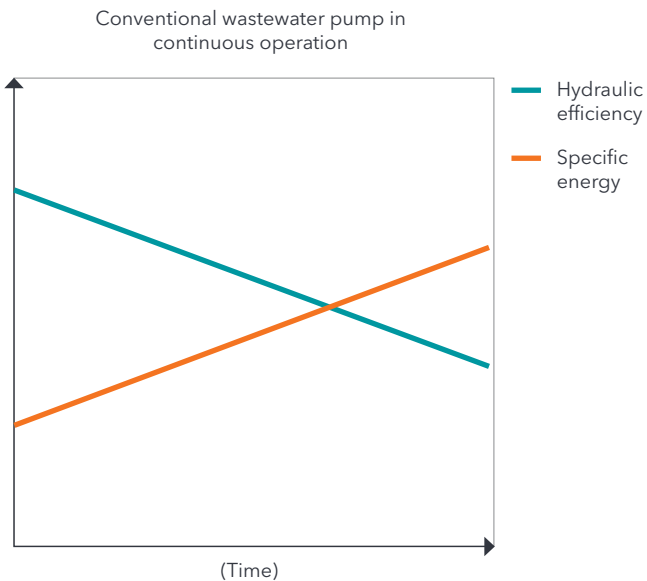

Figure 15: A conventional wastewater pump is partially clogged and the efficiency of pump decreases over time, resulting in increasing specific energy

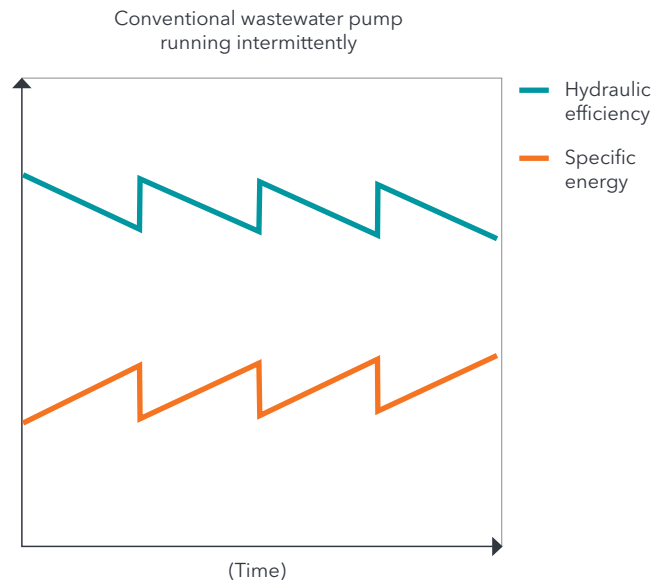

Figure 16: When a wastewater pump is turned off, a reverse flow is generated which flushes the leading edges of the impeller and the volute.

The most demanding wastewater pump scenario is a traditional non-clog pump operated on a variable speed drive. Very often the pump control software will operate the pump(s) at reduced speeds for long periods of time (hours and days). This lack of pump cycling means the pump does not benefit from the back flush that occurs each time the pump is stopped. Compounding the issue for the pump, the control software is often times programmed to perform a "soft stop" in addition to a "soft start." This means that the pump speed is gently brought down until the pump is stopped. The consequence is that a clogged pump will not benefit from the important back flush generated at a hard pump stop, and the pump is less likely to regain its original efficiency

For pumps with self-cleaning pump hydraulics, which now have been on the market for over 10 years, the risk of debris accumulation is very low. This is due to the hydraulic design with extremely back swept leading edges, a relief groove, and sometimes other hydraulic and mechanical augmentations.

The self-cleaning mechanism remains constant and is independent of flow and speed. Therefore, as long as the duty point remains within the pumps allowable operating range, a self-cleaning pump can handle reduced speeds, even down to as low as 50% of full speed without an increased risk of clogging. This results in sustained high efficiency.

In those rare cases where a foreign object causes a complete blockage of the pump, the blockage may be removed automatically by initiating a pump cleaning cycle via the pump controller. Intelligent pump controls can sometimes perform this automatic pump cleaning cycle. During the pump cleaning the impeller is manipulated until it is free of the clogged material.

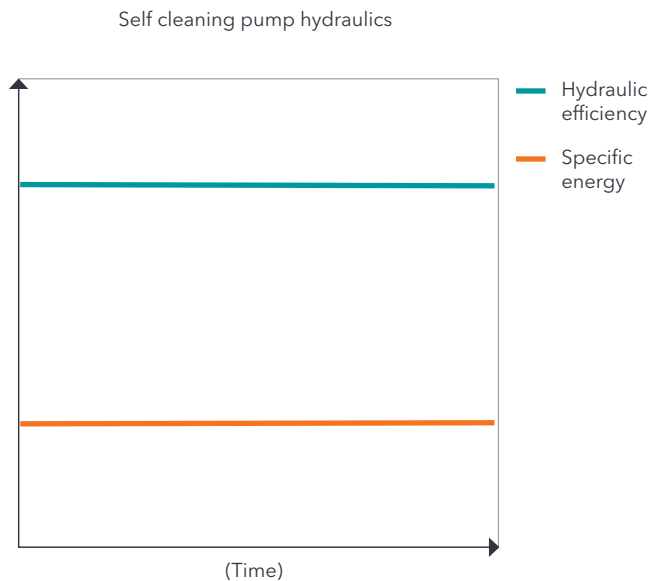

Figure 17: Flygt N-pumps feature mechanical self-cleaning, which implies that the leading edges stay clean and the efficiency is sustained at a high level.

Conclusion

Using a standard drive for variable speed pumping in wastewater applications requires many engineering hours, investigations and implementation of the right control algorithm for wastewater, to achieve energy savings and increased pumping reliability.

Some drives are preprogrammed for controlling pumps with algorithms for various pumping applications. These drives must still be configured and engineered for the specific application.

Application specific intelligent wastewater controls that are pre-programmed with advanced algorithms and preconfigured to ensure reliable wastewater pumping and ease of commissioning are just now entering the market.

These devices will increase the pump stations reliability and will assure that calculated energy saving will be realized. In addition no unnecessary engineering hours will be spent finding a custom control algorithm to a common application challenge.

When pumping at variable speed, it is necessary to consider the system curve, the pumped media, the pump type, the control method and the process requirements to achieve reliable pumping with a high overall efficiency. Pumping with variable speed pumps can result in better process control, energy savings, smoother operation and reduced maintenance costs for the pump station, **when applied correctly.**